

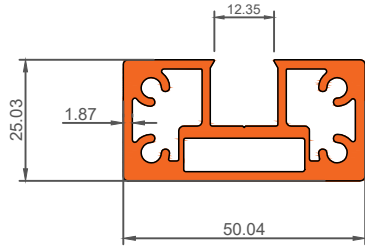

Darshan Extrusions Pvt. Ltd.

Die No. 19603

1.365Kg/m



Die No. 19702

1.095Kg/m

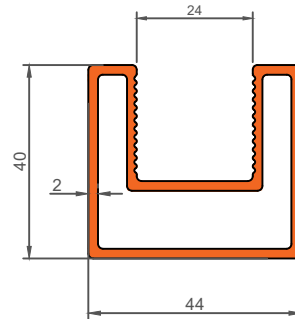

Die No. 19207

1.134Kg/m

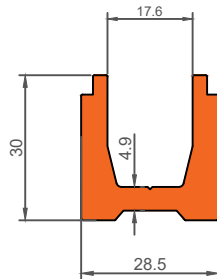

Die No. 7127

1.038Kg/m

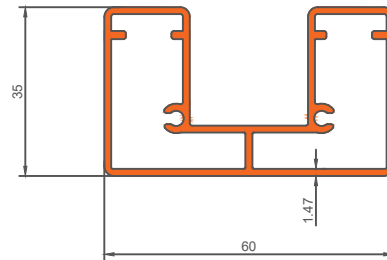

Die No. 7053

1.387Kg/m

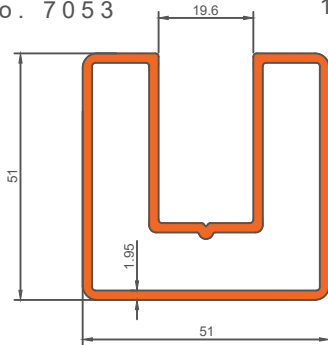

Die No. 9417

0.437 Kg/m

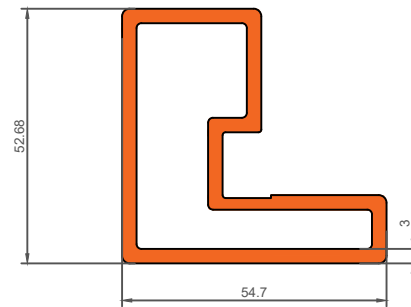

Die No. 19052

1.698Kg/m

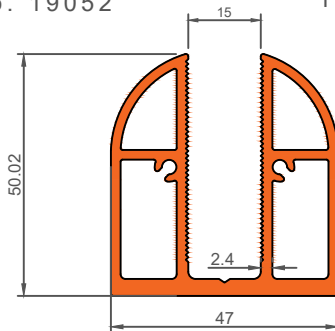

Die No. 1391

0.833Kg/m

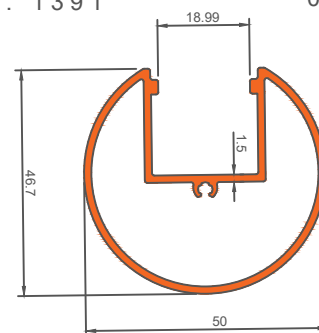

RAILING



Darshan Extrusions Pvt. Ltd.

Die No. 19150

0.967 Kg/m

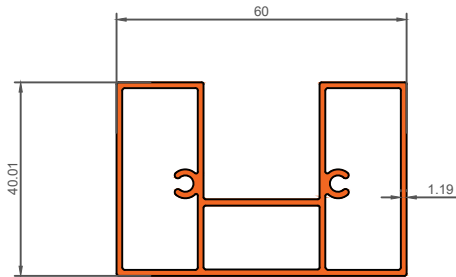

Die No. 19151

0.925 Kg/m

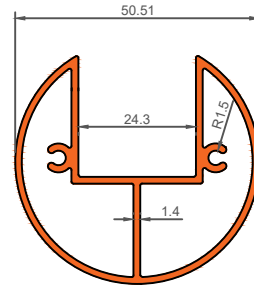

Die No. 19149

3.15 Kg/m

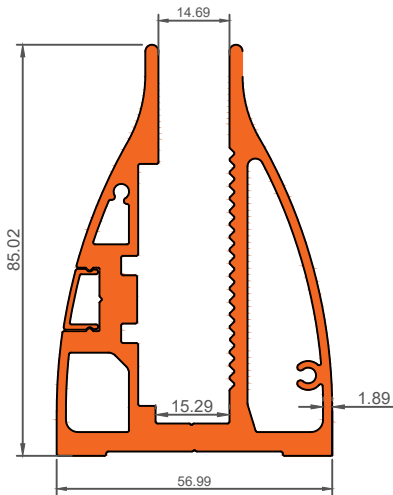

Die No. 19154

0.062 Kg/m

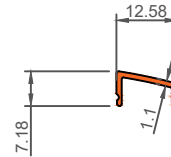

Die No. 21061

2.211 Kg/m

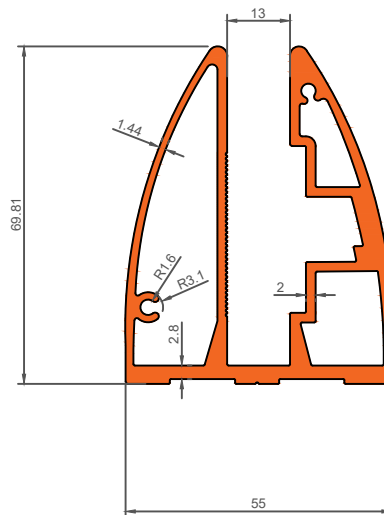

Enq No.841

1.455 Kg/m

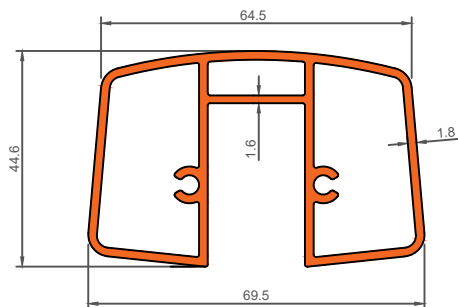

RAILING



Darshan Extrusions Pvt. Ltd.

Die No. 1411

2.815Kg/m

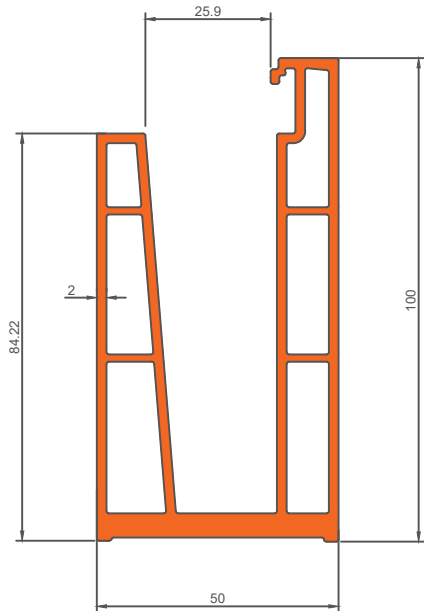

CLIP :-1390

Die No. 19551

3.075Kg/m

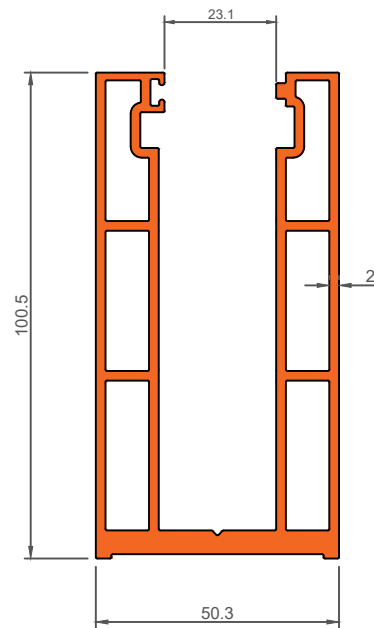

Die No. 21032

2.435Kg/m

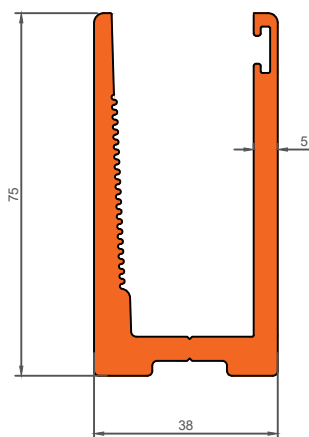

Die No. 1390

0.358Kg/m

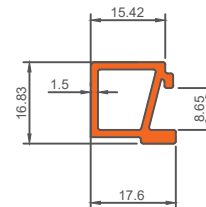

RAILING



Darshan Extrusions Pvt. Ltd.

Die No. 9013

6.127Kg/m

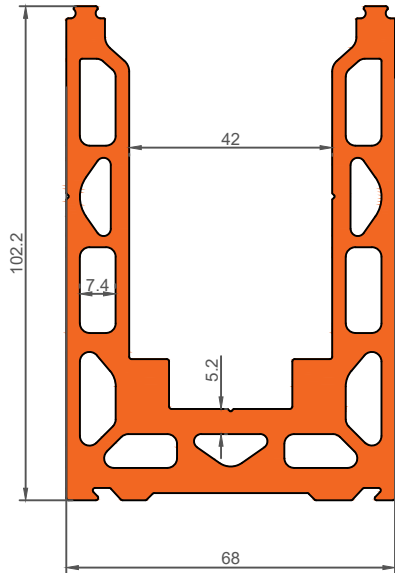

Die No. 19148

7.278Kg/m

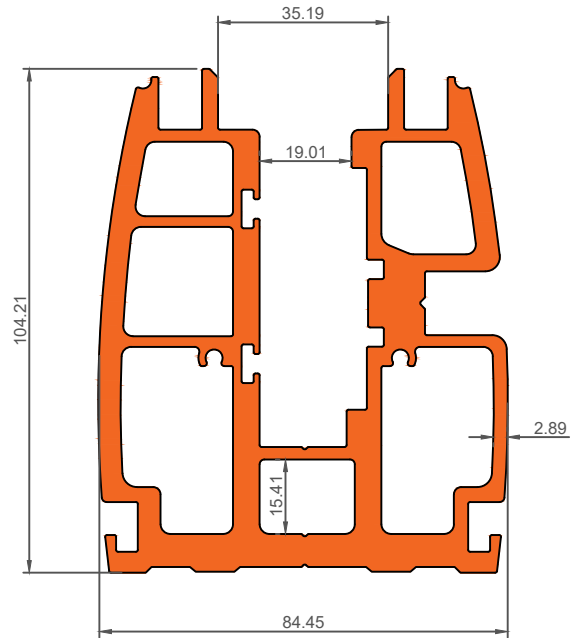

Die No. 7117

4.425Kg/m

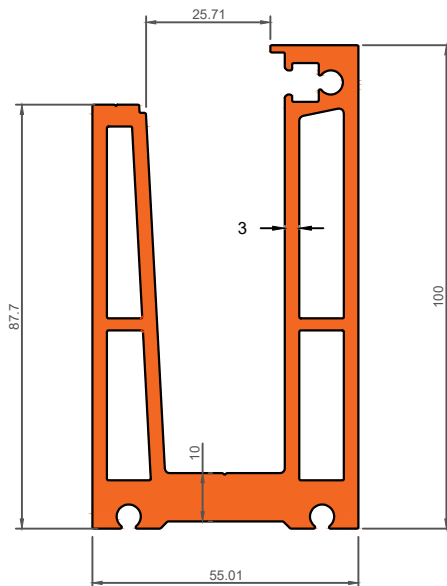

Die No. 7118

0.295Kg/m

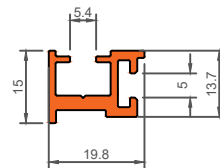

CLIP :-7118

RAILING



Darshan Extrusions Pvt. Ltd.

Die No. 9162

5.424Kg/m

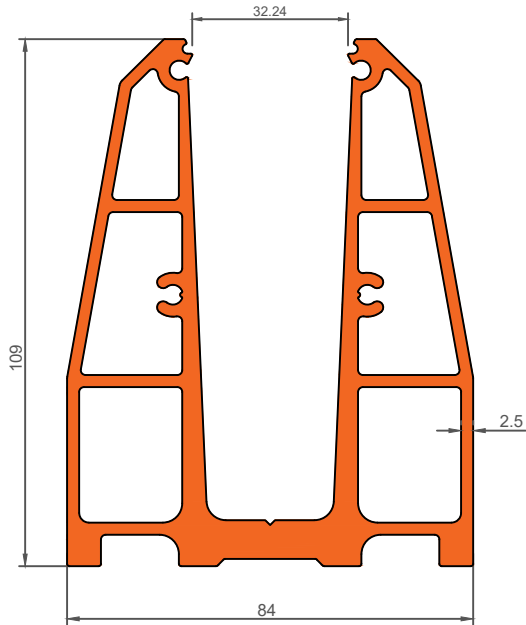

Die No. 9260

3.439Kg/m

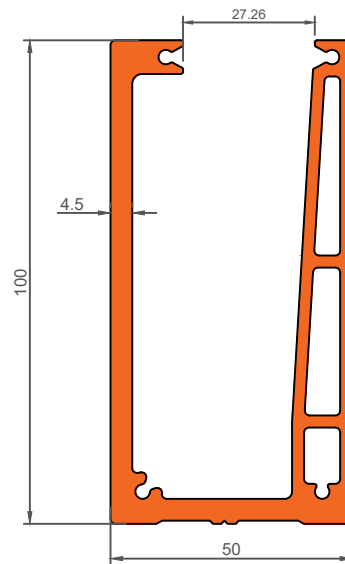

Die No. 7136

1.946Kg/m

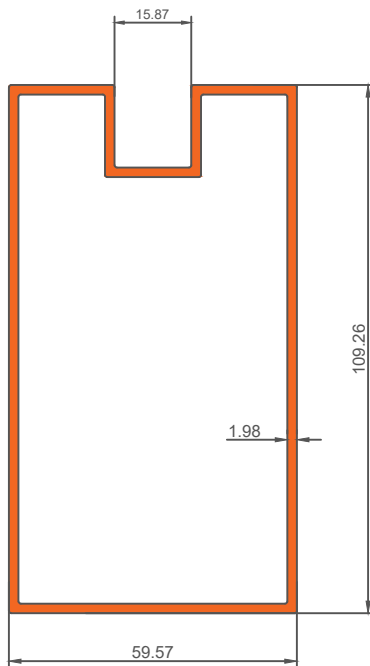

Die No.P-8041

4.991Kg/m

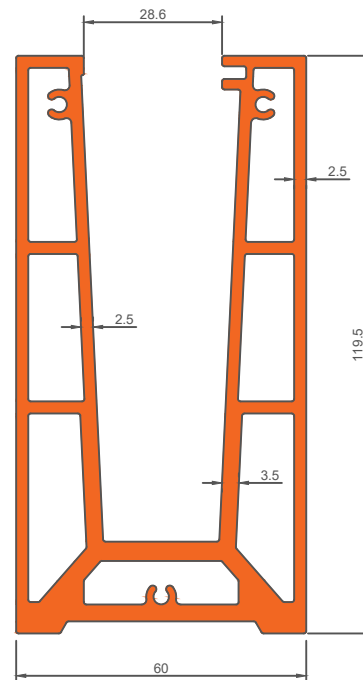

RAILING



Darshan Extrusions Pvt. Ltd.

Die No. 19549

6.039Kg/m

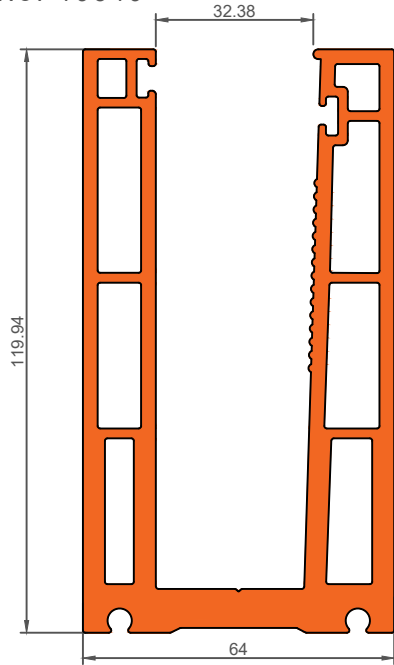

Die No. 9528

8.166Kg/m

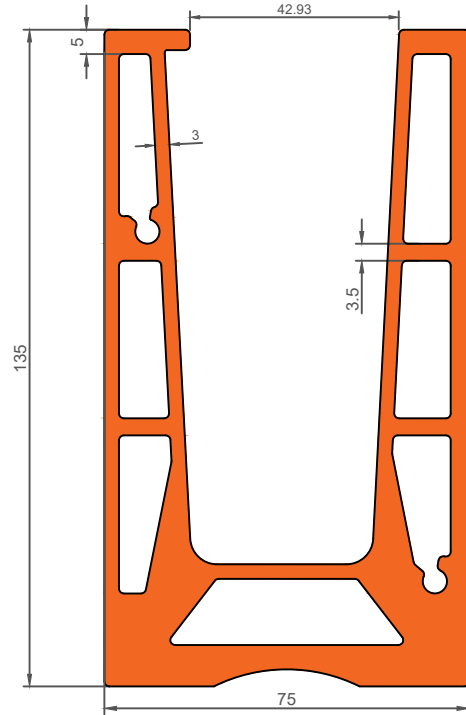

Die No. 9564

6.114Kg/m

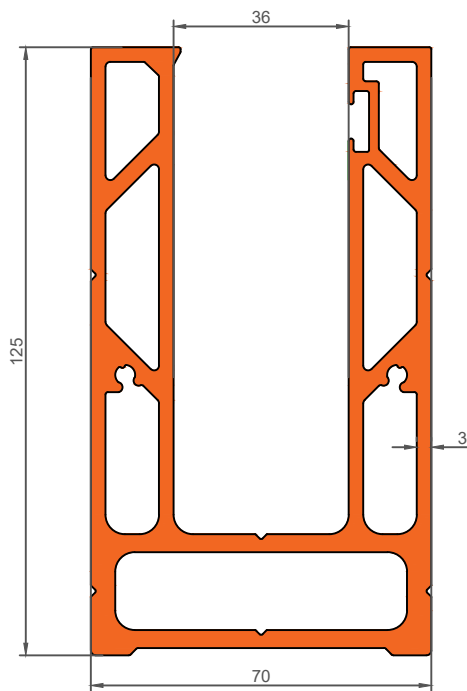

RAILING



Darshan Extrusions Pvt. Ltd.

Die No. 19116

5.397Kg/m

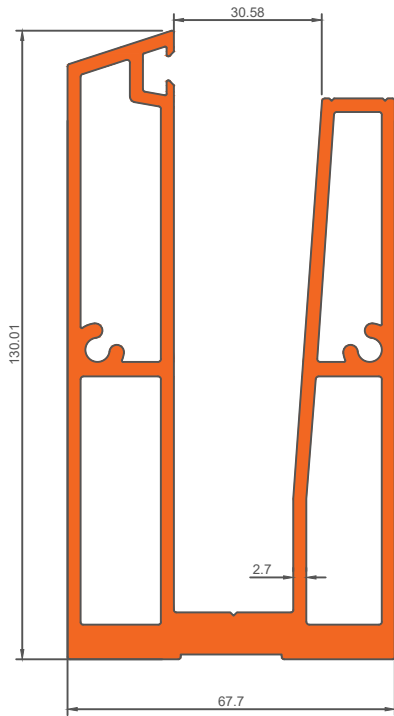

CLIP :-19118

Die No. 19117

4.825Kg/m

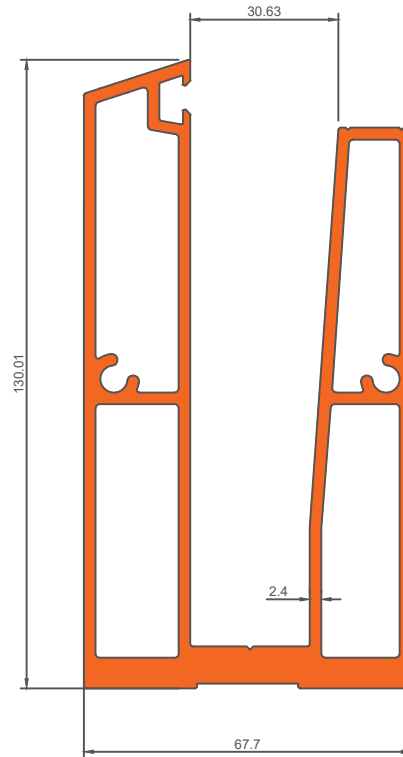

CLIP :-19118

Die No. 19118

0.260Kg/m

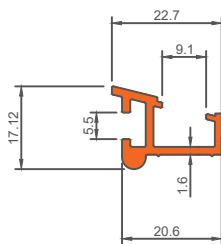

RAILING



Darshan Extrusions Pvt. Ltd.

Die No. 9065

5.577Kg/m

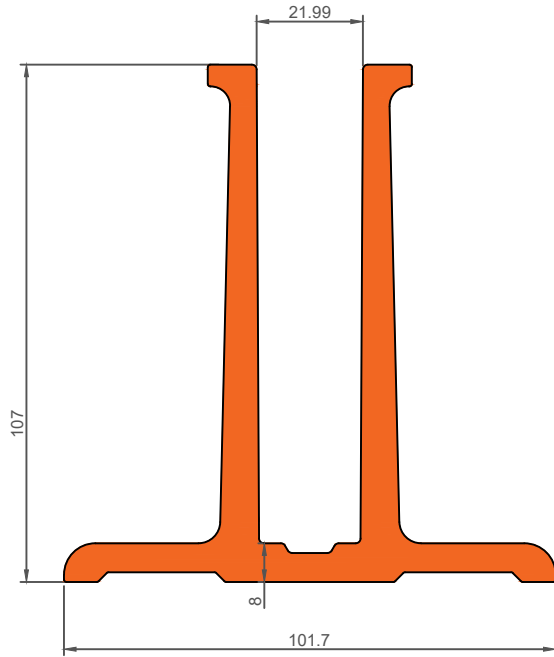

Die No. 9555

4.907Kg/m

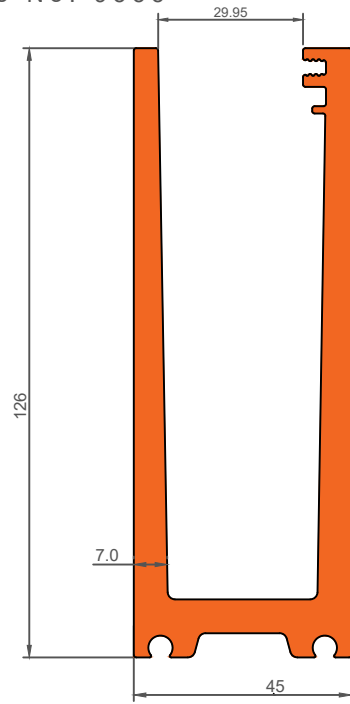

Die No. 9565

4.244Kg/m

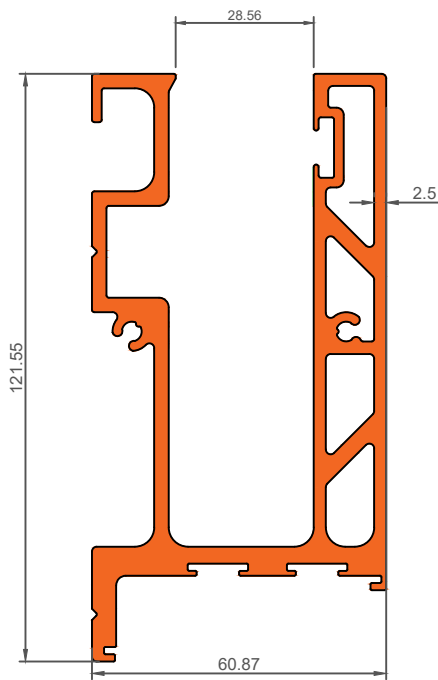

Die No. 19010

2.298Kg/m

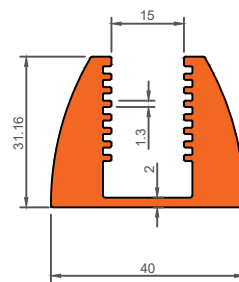

RAILING



Darshan Extrusions Pvt. Ltd.

Die No. 19985

1.829Kg/m

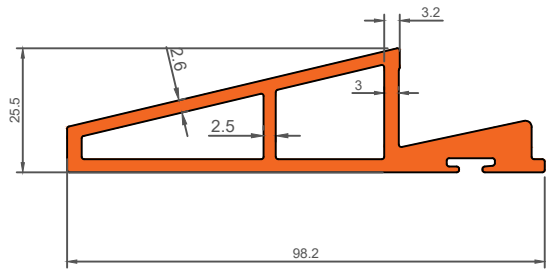

Die No. 19942

0.764Kg/m

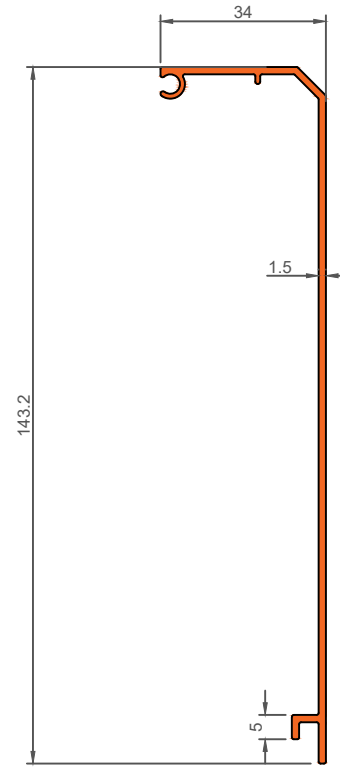

RAILING



Darshan Extrusions Pvt. Ltd.

Die No. 19982

6.202Kg/m

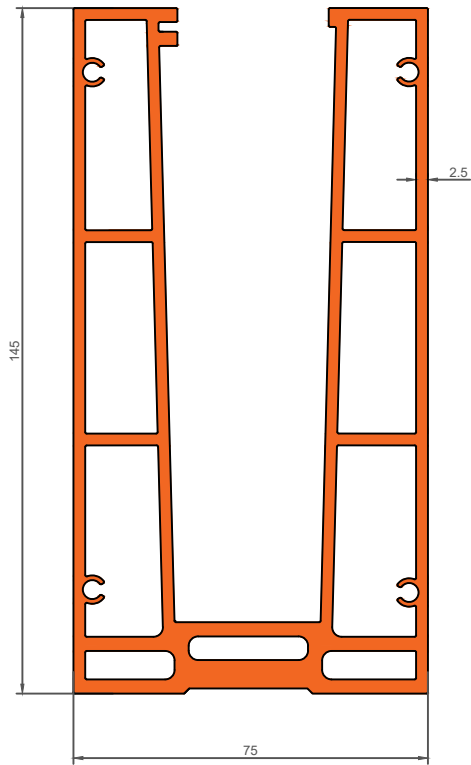

Die No. 19141

5.854Kg/m

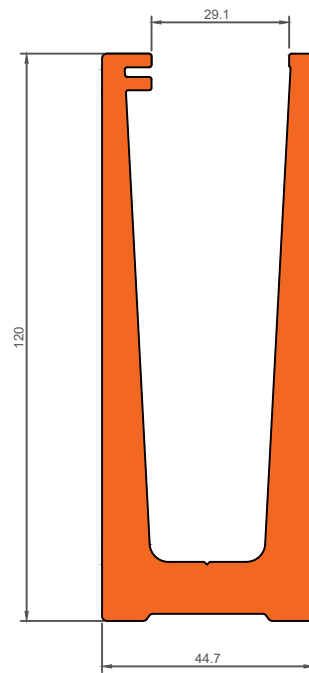

Die No. 9259

2.683Kg/m

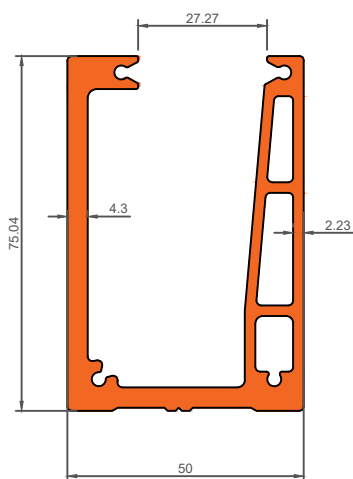

RAILING



Die No. 19553

2.822 Kg/m

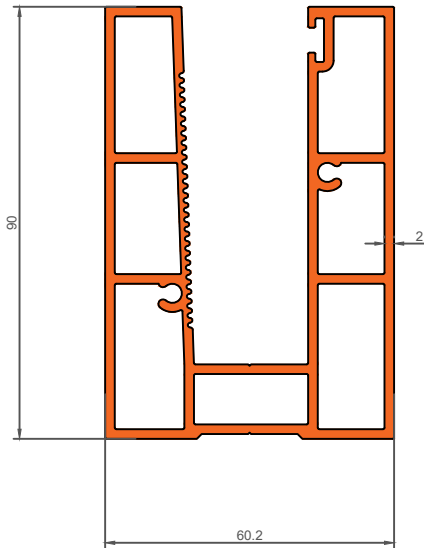

Die No.10049

0.896Kg/m

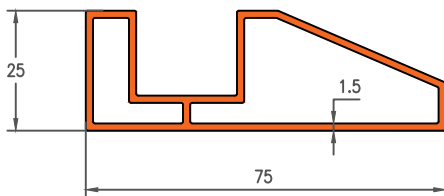

RAILING